

2MP WDR Lighthunter IR Network Dome Camera

IPC3232SB-AHDZK-IO



Key Features



- High quality image with 2MP,1/2.8" CMOS sensor
- 1920*1080@60fps in the main stream, deliver detailed live while 60fps keeping it smooth and closer to the real image
- Ultra 265, H.265, H.264, MJPEG
- 5X optical zoom allows for closer viewing of subjects
- Smart intrusion prevention, support false alarm filtering, include Cross Line, Intrusion, Enter Area, Leave Area detection
- People Counting, support people flow counting and crowd density monitoring, suitable for different statistical scenarios
- Lighthunter product technology ensures ultra-high image quality in low illumination environment
- Up to 120 dB Optical WDR (Wide Dynamic Range)
- DC12V or PoE (IEEE 802.3af) power supply
- Wide voltage range of $\pm 25\%$ in DC
- Audio 1 in and 1 out, Alarm 2 in and 1 out

Specifications

IPC3232SB-AHDZK-IO					
Camera					
Sensor	1/2.8", 2.0 megapixel, progressive scan, CMOS				
Min. Illumination	Colour:0.001 lux (F1.2, AGC ON) 0 lux with IR				
Day/Night	IR-cut filter with auto switch (ICR)				
Shutter	Auto/Manual, 1 ~ 1/100000s				
Angle Adjustment	Pan: 0° to 355°, tilt: 0° to 70°, rotate: 0° to 355°				
WDR	120dB				
S/N	>52dB				
Lens					
Lens type	2.7~13.5mm@F1.2, AF automatic focusing and motorized zoom lens				
Iris	Fixed				
Field of View (H)	98.2°~30.6°				
Field of View (V)	53.3°~ 17.3°				
Field of View (D)	127.7°~37.6°				
DORI					
DORI Distance	Lens (mm)	Detect (m)	Observe (m)	Recognize (m)	Identify (m)
	2.7	70.9(232.5ft)	28.4(93.0ft)	14.2(46.5ft)	7.1(23.3ft)
	13.5	247.5(812.0ft)	99.0(324.8ft)	49.5(162.4ft)	24.8(81.2ft)
Illuminator					
IR Range	Up to 50m (164 ft) IR range				
Wavelength	850nm				
IR On/Off Control	Auto/Manual				
Video					
Video Compression	Ultra 265, H.265, H.264, MJPEG				
Frame Rate	Main Stream: 1080P (1920*1080),Max 60fps; Sub Stream: 1080P (1920*1080), Max 60fps; Third Stream: D1 (720*576), Max 60fps				
Video Bit Rate	128 Kbps~16 Mbps				
ROI	Up to 8 areas				
Video stream	Triple streams				
OSD	Up to 8 OSDs				
Privacy Mask	Up to 4 areas per scene				
Image					
White Balance	Auto/Outdoor/Fine Tune/Sodium Lamp/Locked/Auto2				
Digital noise reduction	2D/3D DNR				
Smart IR	Support				
Flip	Normal/Flip Vertical/Flip Horizontal/180°/90°Clockwise/90°Anti-clockwise				
HLC	Support				
BLC	Support				
Defog	Digital Defog				
Intelligent					
Smart intrusion	Support false alarm filtering: Cross Line detection, Intrusion detection, Enter Area detection, Leave Area detection				

prevention	
Statistical Analysis	People counting, support people flow counting and crowd density monitoring
Events	
Basic Detection	Motion detection, Audio detection, Tampering alarm
General Function	Watermark, IP Address Filtering, Alarm input, Alarm output, Access Policy, ARP Protection, RTSP Authentication, User Authentication
Audio	
Audio Compression	G.711U, G.711A
Audio Bitrate	64 Kbps
Two-way Audio	Support
Suppression	Support
Sampling Rate	8KHZ
Storage	
Edge Storage	Micro SD, up to 256 GB
Network Storage	ANR,NAS(NFS)
Network	
Protocols	IPv4, IGMP, ICMP, ARP, TCP, UDP, DHCP, PPPoE, RTP, RTSP, RTCP, DNS, DDNS, NTP, FTP, UPnP, HTTP, HTTPS, SMTP, 802.1x, SNMP, QoS, RTMP, SSL/TLS
Compatible Integration	ONVIF (Profile S, Profile G, Profile T), API, SDK
User/Host	Up to 32 users. 3 user levels: administrator, operator and common user
Security	Password protection, strong password, HTTPS encryption, basic and digest authentication for RTSP, digest authentication for HTTP, TLS 1.2, WSSE and digest authentication for ONVIF
Client	EZStation EZLive EZview
Web Browser	Plug-in required live view: IE 10 and above, Chrome 45 and above, Firefox 52 and above, Edge 79 and above
Interface	
Audio I/O	1/1
Alarm I/O	2/1
Serial Port	1 RS485
Built-in Mic	Support
Video output	1 BNC(For debugging)
Network	1 * RJ45 10M/100M Base-TX Ethernet
Certification	
EMC	CE-EMC (EN 55032: 2015+A1:2020,EN 61000-3-3: 2013+A1: 2019,EN IEC 61000-3-2: 2019+A1: 2021,EN 55035: 2017+A11:2020) FCC (FCC CFR 47 part15 B, ANSI C63.4-2014)
Safety	CE LVD (EN 62368-1:2014+A11:2017) CB (IEC 62368-1:2014) UL (UL 62368-1, 2nd Ed., Issue Date: 2014-12-01)
Environment	CE-RoHS (2011/65/EU;(EU)2015/863); WEEE (2012/19/EU); Reach (Regulation (EC) No 1907/2006)
Protection	IP67 (IEC 60529:1989+AMD1:1999+AMD2:2013) IK10 (IEC 62262:2002)
General	
Power	DC12V(±25%), PoE(IEEE 802.3af)
	Power consumption: Max 8W
Power Interface	Ø 5.5mm coaxial power plug
Dimensions (Ø x H)	Φ148.0 x 111.4mm (Φ5.8" x 4.4")
Weight	0.93kg(2.16lb)

Working Environment	-30°C ~ 60°C (-22°F ~ 140°F), Humidity: ≤95% RH (non-condensing)
Storage Environment	-40°C ~ 70°C (-40°F ~ 158°F), Humidity: ≤95% RH (non-condensing)
Surge protection	6KV
Reset button	Support

Dimensions

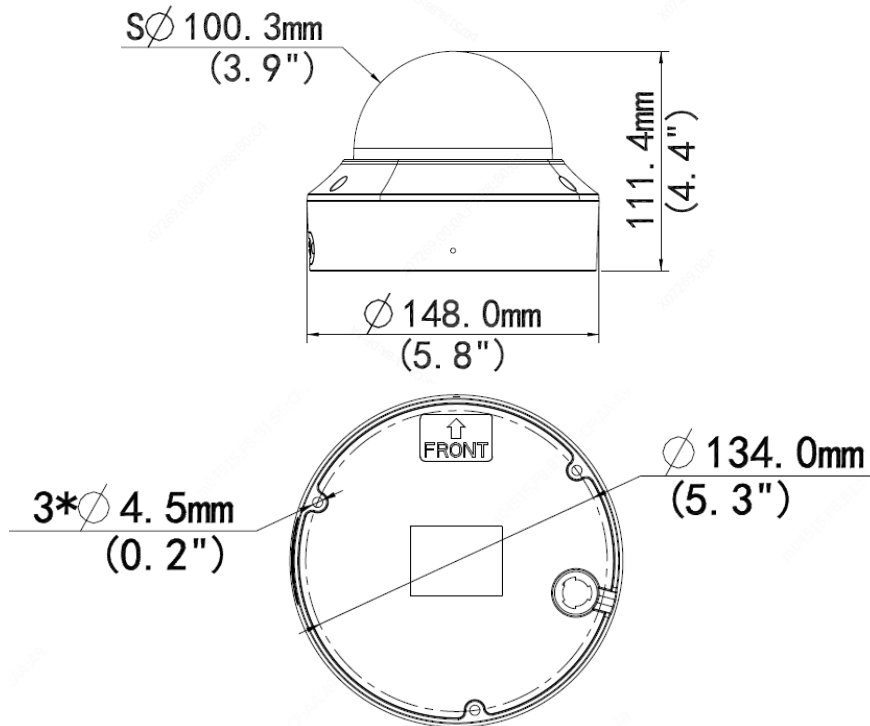

Accessories

TR-JB04-C-IN
Junction Box



TR-JB07/WM04-B-IN
Wall Mount



TR-WM04-IN
Wall Mount



TR-FM152-A-IN
In-ceiling Mount



TR-SM04-IN
Electric-box Transfer Plate



TR-A01-IN(Optional)
Waterproof Joint



TR-UP06-IN
Pole Mount



TR-SE24-IN
Pendant Mount



TR-SE24-A-IN
Pendant Mount



TR-CM24-IN

Pendant Mount



Junction Mount	Wall mount
TR-JB04-C-IN+ TR-A01-IN	TR-JB07/WM04-B-IN,TR-WM04-IN+TR-UP06-IN
In-ceiling Mount	Electric-box Transfer plate
TR-FM152-A-IN	TR-SM04-IN
Indoor pendant mount	
TR-JB04-C-IN + TR-SE24-IN/TR-SE24-A-IN + TR-CM24-IN	

Zhejiang Uniview Technologies Co., Ltd.

Building No.10, Wanlun Science Park, Jiangling Road 88, Binjiang District, Hangzhou, Zhejiang, China (310051)

 Email: overseasbusiness@uniview.com; globalsupport@uniview.com
<http://www.uniview.com>

©2022 Zhejiang Uniview Technologies Co., Ltd. All rights reserved.

*Product specifications and availability are subject to change without notice